

The Role of Adaptive Control in Quantum Information Systems

Mark's Autonomous Control Laboratory

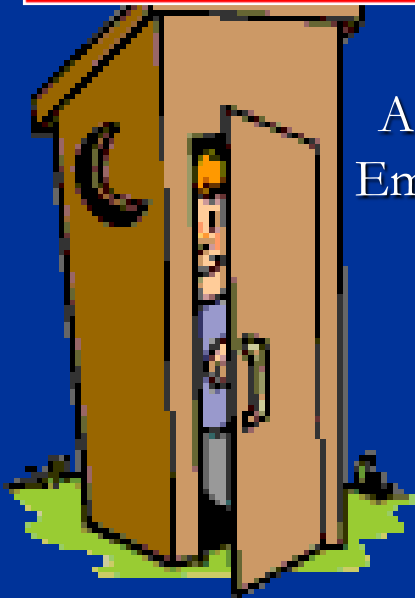

Mark J. Balas
Distinguished Professor
Aerospace Engineering Department
Embry-Riddle Aeronautical University
Daytona Beach, FL

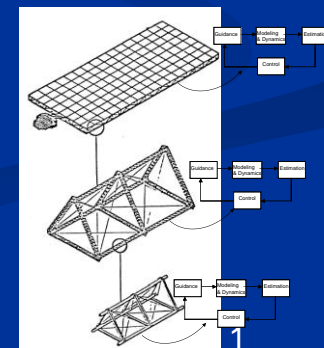

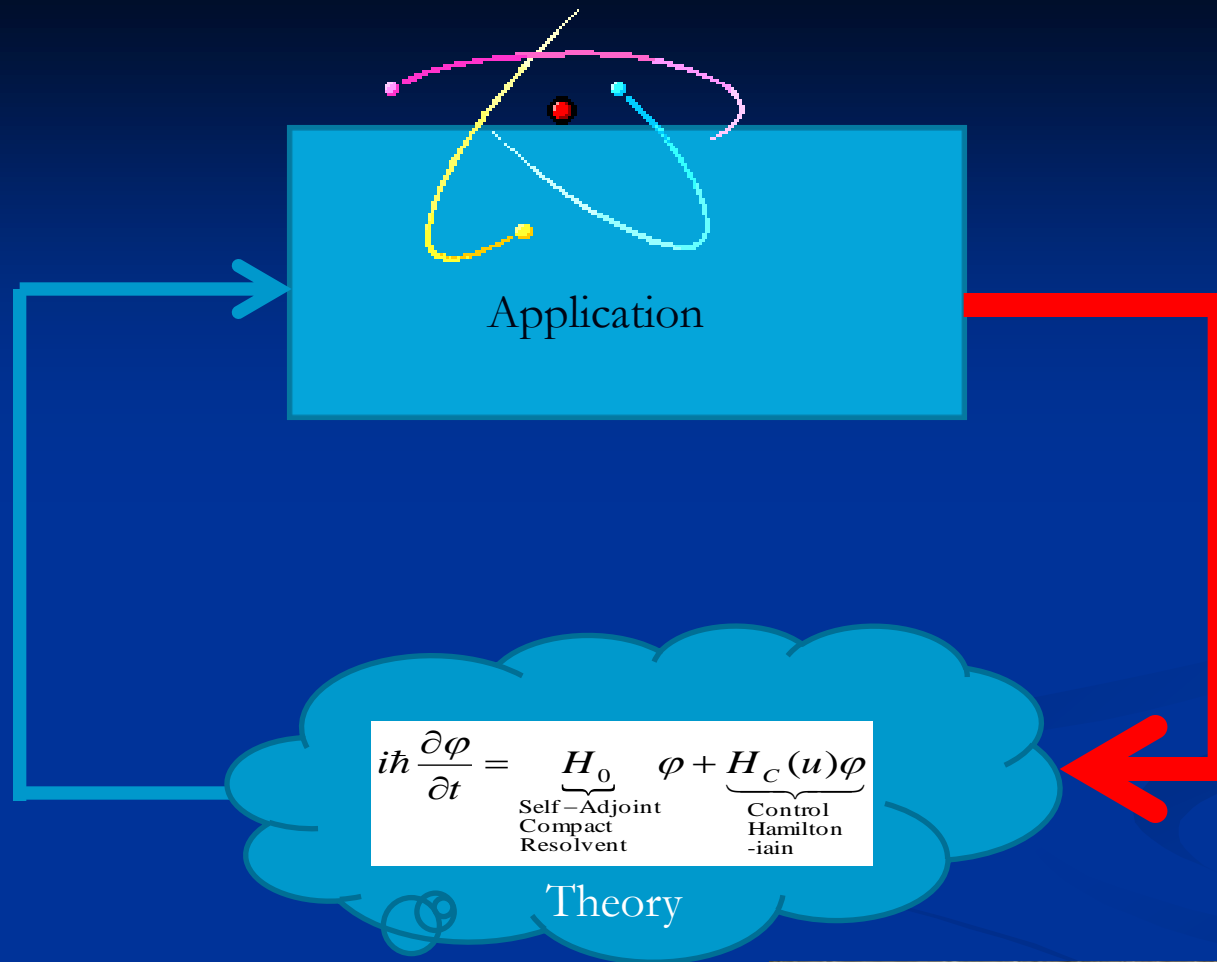

It's not theories about stars;
it's the **actual** stars that count.”

..... Freeman Dyson



Indirect Adaptive Control

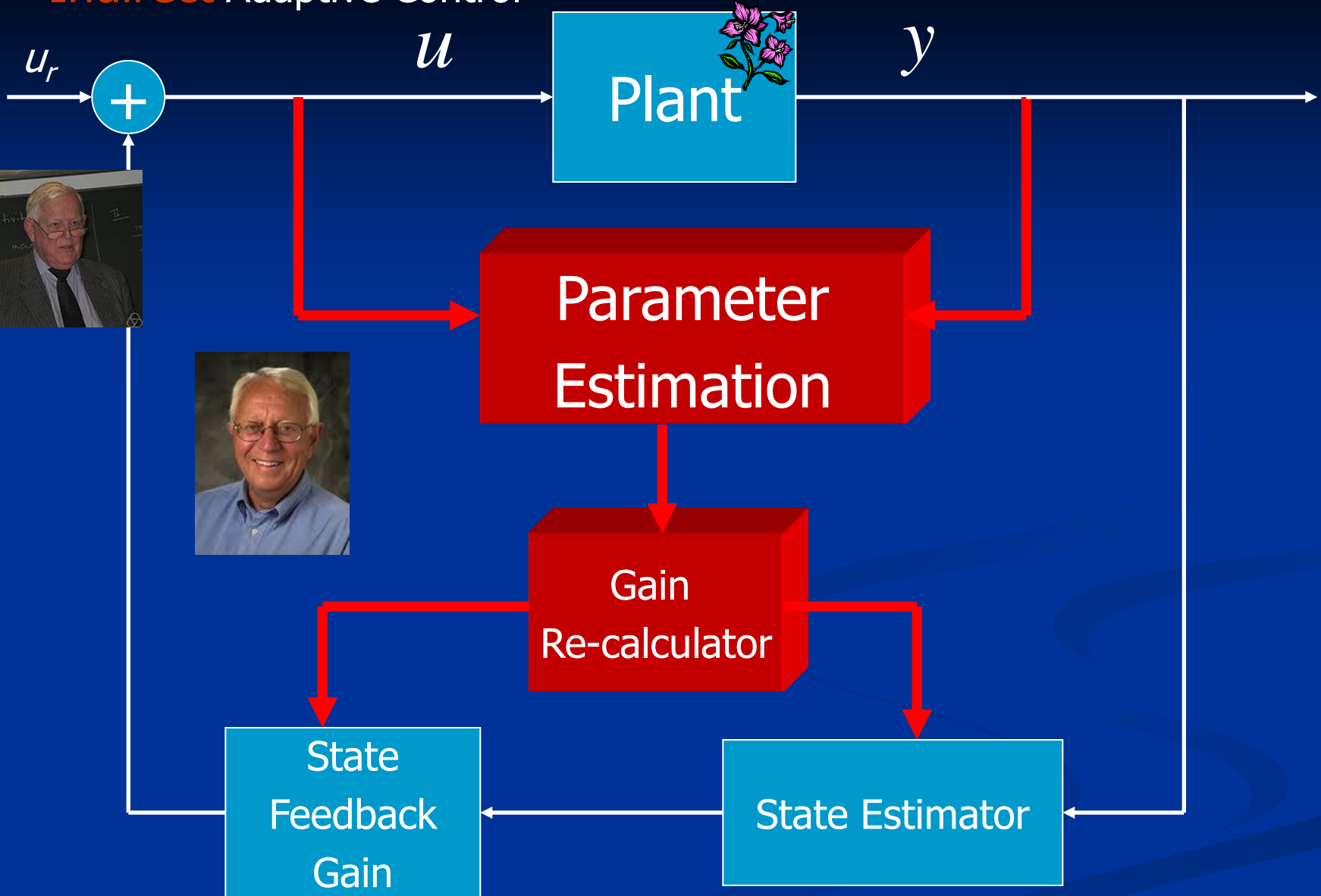

Note: Called "Self-Organizing" System (Kalman)
& "Self-Tuning" Regulator (Astrom)

Direct Adaptive Model Following Control (Wen-Balas 1989)

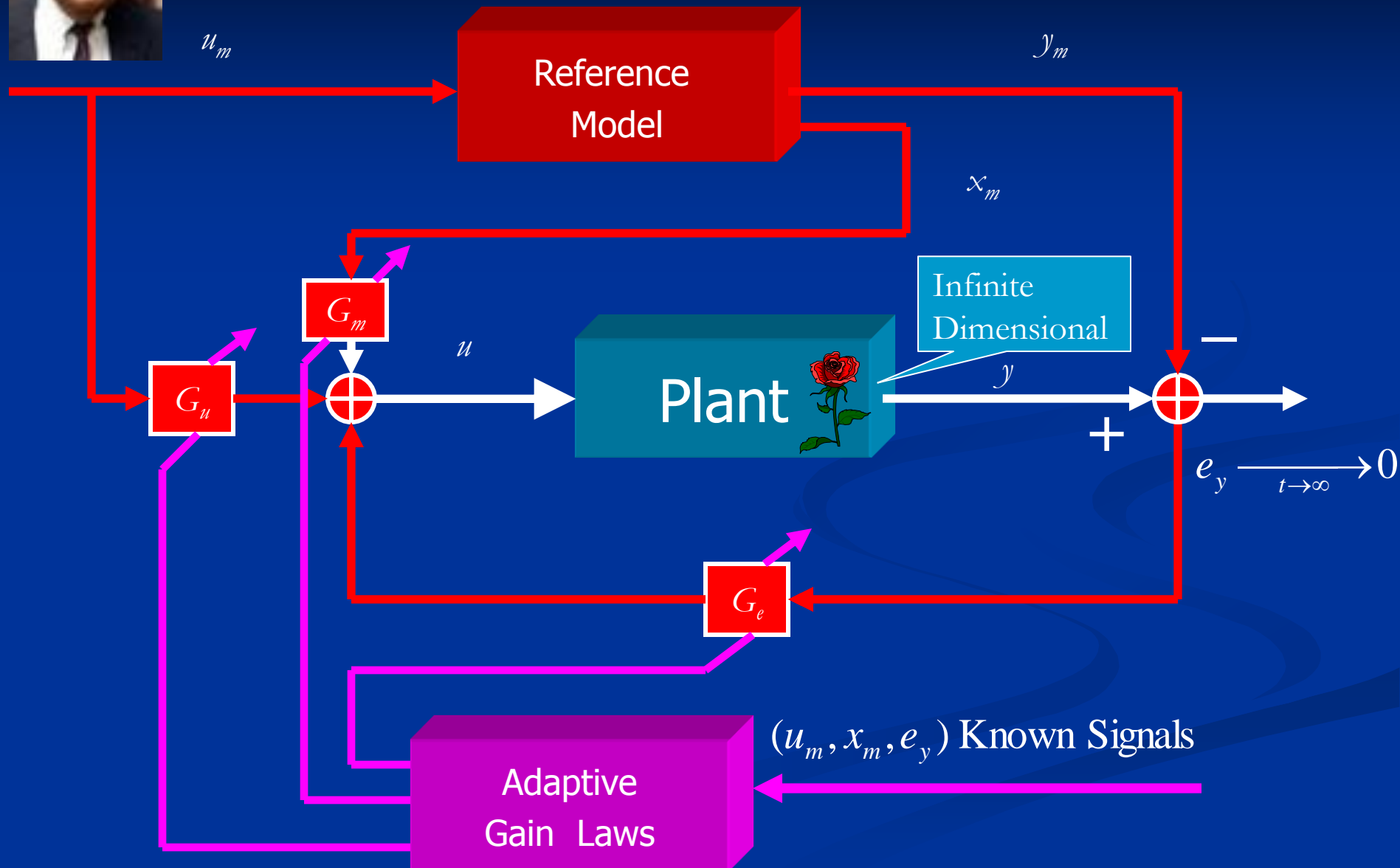

Direct Adaptive Persistent Disturbance Rejection (Fuentes-Balas 2000)

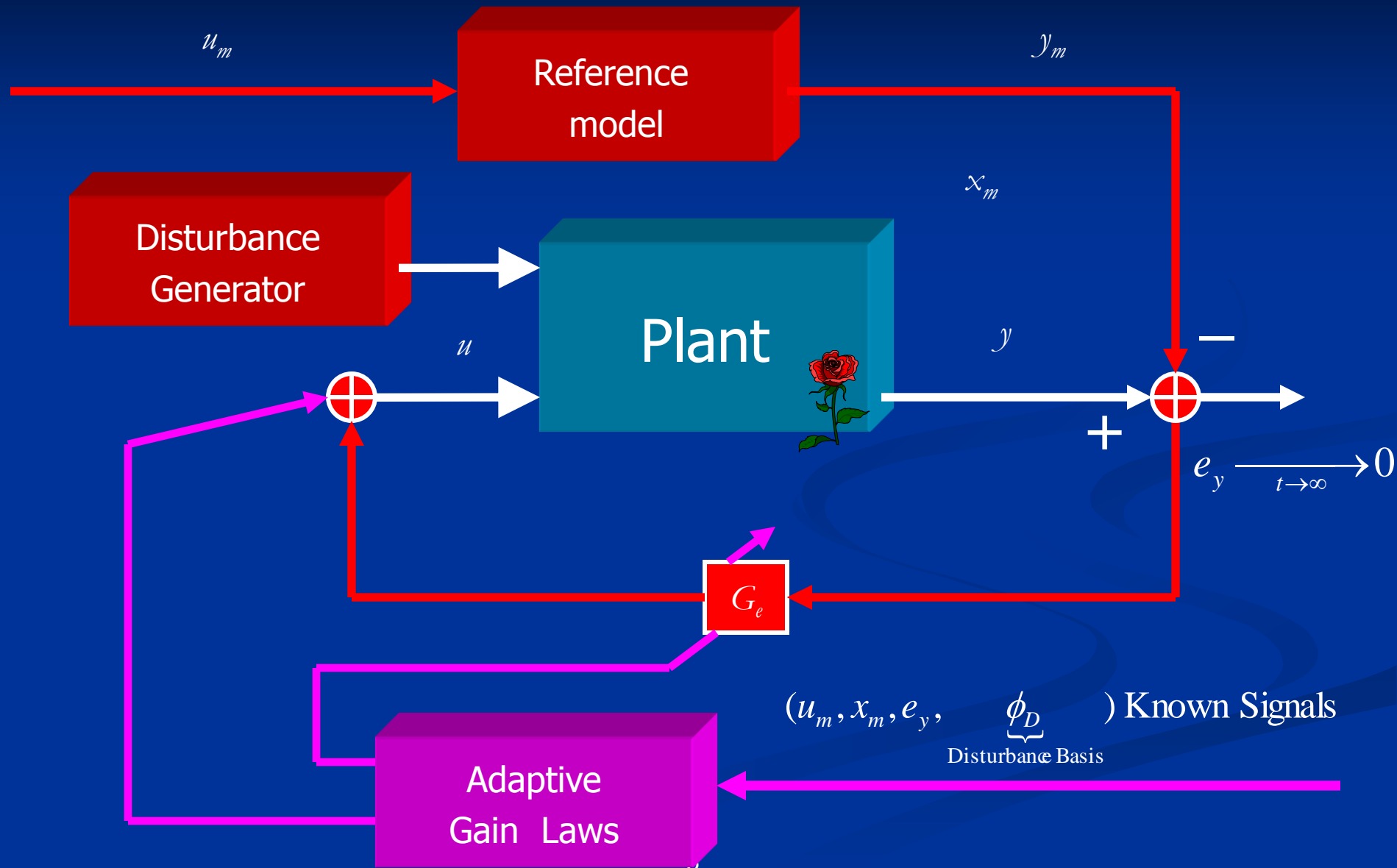

Persistent Disturbance Example

$$\begin{bmatrix} \dot{\theta} \\ \ddot{\theta} \end{bmatrix} = \underbrace{\begin{bmatrix} 0 & 1 \\ 0 & 0 \end{bmatrix}}_A \begin{bmatrix} \theta \\ \dot{\theta} \end{bmatrix} + \underbrace{\begin{bmatrix} 0 \\ 1 \end{bmatrix}}_B u(t) + \underbrace{\begin{bmatrix} 0 \\ 1 \end{bmatrix}}_\Gamma u_D$$

Disturbances

$$u_D \equiv A_D \sin(\omega_D t + \varphi_D) = \underbrace{\begin{bmatrix} l_1 & l_2 \end{bmatrix}}_{L\theta} \underbrace{\begin{bmatrix} \sin \omega_D t \\ \cos \omega_D t \end{bmatrix}}_{\phi_D}$$

Known Basis

$$u_D \equiv a_0 + a_1 t + a_2 t^2 = \underbrace{\begin{bmatrix} a_0 & a_1 & a_2 \end{bmatrix}}_{L\theta} \underbrace{\begin{bmatrix} 1 \\ t \\ t^2 \end{bmatrix}}_{\phi_D}$$

Known Basis

Unknown

Adaptive Control Is Not Complicated !

Adaptive Regulation

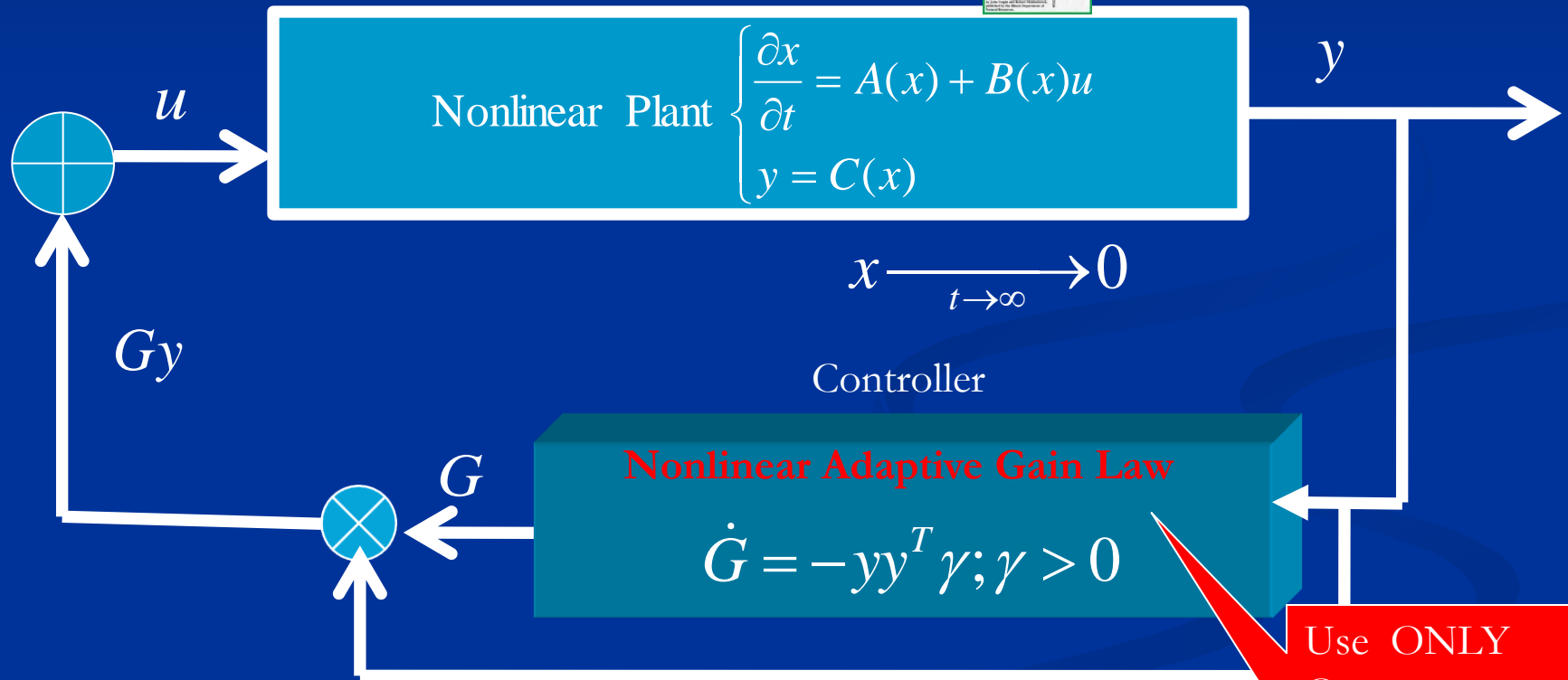

Use ONLY Outputs & Know Almost NOTHING about the Plant

“Simplicity” via Infinite Dimensional Spaces



$$\left\{ \begin{array}{l} \frac{\partial x}{\partial t} = A(x) + B(x)u \\ x(0) = x_0 \in X \text{ Banach or Hilbert Space} \\ y = C(x) \end{array} \right. \Rightarrow x(t, w_0) = \underbrace{U(t)x_0}_{\substack{\text{Linear or Nonlinear} \\ \text{Evolution} \\ \text{in } X}} ; \forall t \geq 0$$

“Boil Away” all the special properties of

\mathbb{R}^N

Infinite-Dimensional Space

Viewpoint: **Linear** Semigroups

Hilbert Space
with inner
product (x, y)

$$\begin{cases} \frac{\partial x}{\partial t} = Ax + F \\ x(0) = x_0 \end{cases}$$

$A : D(A) \subseteq X \rightarrow X$ closed, densely defined linear operator

$$\Rightarrow x(t, w_0) = U(t)x_0 + \int_0^t U(t-\tau)F(\tau)d\tau \in X; \forall t \geq 0$$

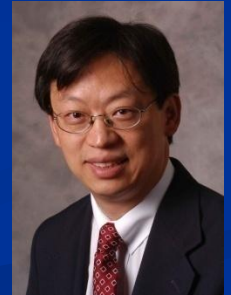

C_0 – Semigroup of Bounded Operators $U(t)$:

$$\begin{cases} U(t+s) = U(t)U(s) \text{ (semigroup property)} \\ \frac{d}{dt}U(t) = AU(t) = U(t)A \text{ (} A \text{ generates } U(t)\text{)} \\ U(t)x_0 \xrightarrow{t \rightarrow 0} x_0 \text{ (continuous at } t = 0\text{)} \end{cases}$$

J. Wen & M. Balas, "Robust Adaptive Control in Hilbert Space",
J. Mathematical. Analysis and Applications, Vol 143,
pp 1-26, 1989.

J. Wen & M. Balas, "Direct Model Reference Adaptive Control in Infinite-Dimensional Hilbert Space," Chapter in Applications of Adaptive Control Theory, Vol.11, K. S. Narendra, Ed., Academic Press, 1987

Example: Heat Diffusion

$$\left\{ \begin{array}{l} \frac{\partial x}{\partial t} = \frac{\partial^2 x}{\partial z^2} + bu; \\ b(z) \in D(A) \equiv \{x / \text{smooth and BC: } x(t, 0) = x(t, l) = 0\} \\ \qquad \qquad \qquad \subset X \equiv L^2(\Omega) \\ \text{with } (x, y) \equiv \int_{\Omega} x(t)y(t)dt \\ x(0) = x_0 \in D(A) \\ y = (c, x); \quad c(z) \in D(A) \end{array} \right.$$

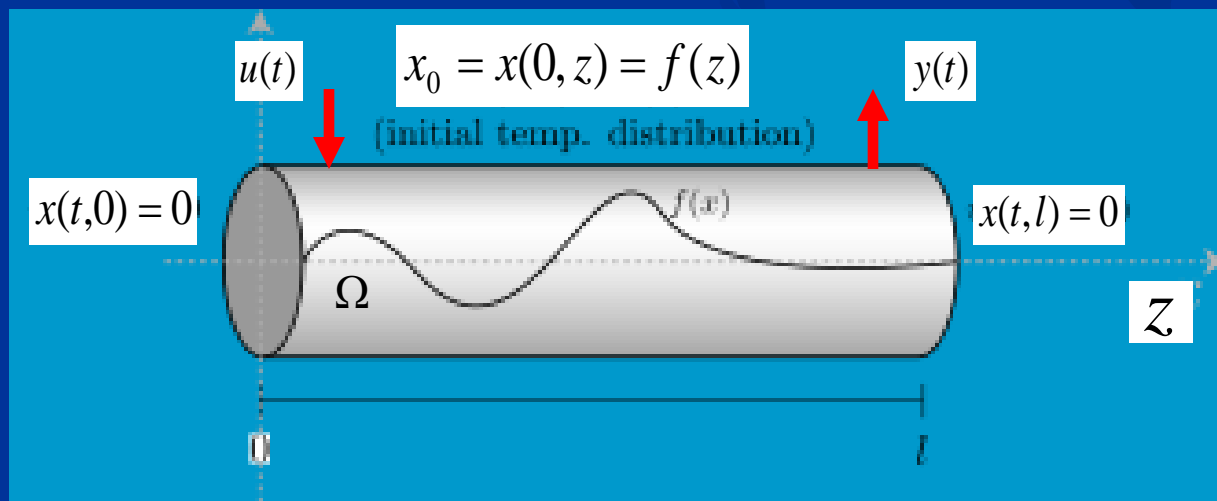

Euler-Bernoulli Beam

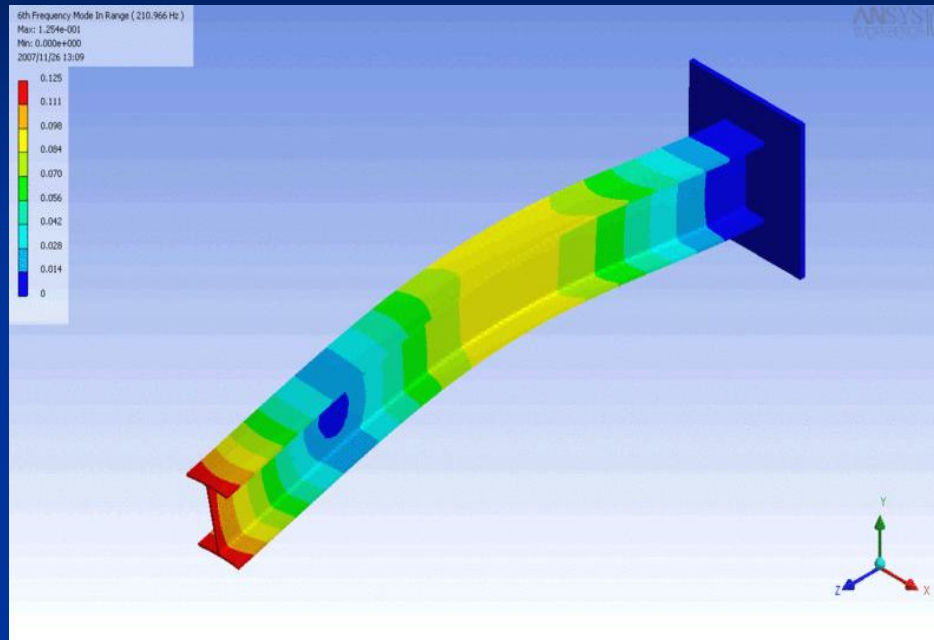

$$\frac{\partial}{\partial t} \begin{bmatrix} w \\ w_t \end{bmatrix} = \underbrace{\begin{bmatrix} 0 & I \\ -\frac{EI}{\rho} \frac{\partial^4}{\partial z^4} & 0 \end{bmatrix}}_A \begin{bmatrix} w \\ w_t \end{bmatrix} + \underbrace{\begin{bmatrix} 0 \\ b(z) \end{bmatrix}}_{u(t)}$$

Symmetric Hyperbolic Systems

$$\frac{\partial \underline{\varphi}}{\partial t} = \underbrace{\sum_{i=1}^n \underbrace{A_i}_{\substack{|l| \text{ constant} \\ \text{symmetric}}} \frac{\partial \underline{\varphi}}{\partial z_i} + \underbrace{A_0}_{|l| \text{ constant}} \underline{\varphi}}_{A \underline{\varphi}}; \underline{x} \in D(A) \subset X \equiv L^2(\Omega; \mathfrak{R}^l)$$

Boundary

Conditions : $\Lambda(z)\varphi(z, t) = 0 \forall z \in \partial\Omega; t \geq 0$

Theorem : (Balas 1974, w help from Lax - Phillips 1967)

1) Symbol : $A(\xi) \equiv \sum_{i=1}^n \xi_i A_i$ is nonsingular $\forall \xi \neq 0 \in \mathfrak{R}^n$

2) $A_0 + A_0^* \leq 0$

3) $\dim N(A) < \infty$

4) Boundary Conditions are Coercive ($\overset{\text{Sobolev Norm}}{\|\underline{\varphi}\|_1} \leq \|\underline{\varphi}\| + \|A\underline{\varphi}\|$)

$\Rightarrow (A\underline{\varphi}, \underline{\varphi}) + (\underline{\varphi}, A\underline{\varphi}) = 0$ and A has compact resolvent.

Examples

Wave Equation

$$\text{2-dim wave equation } \frac{\partial^2 x}{\partial t^2} = \underbrace{\left(\frac{\partial^2 x}{\partial z_1^2} + \frac{\partial^2 x}{\partial z_2^2} \right)}_{\Delta x} + \gamma x$$

$$\Leftrightarrow \underline{x}_t = \underbrace{\begin{bmatrix} 0 & 0 & 0 & 1 \\ 0 & 0 & 1 & 0 \\ 0 & 1 & 1 & 0 \\ 1 & 0 & 0 & 0 \end{bmatrix}}_{A_1} \frac{\partial \underline{x}}{\partial z_1} + \underbrace{\begin{bmatrix} 0 & 0 & -1 & 0 \\ 0 & 0 & 0 & 1 \\ -1 & 0 & 1 & 0 \\ 0 & 1 & 0 & 0 \end{bmatrix}}_{A_2} \frac{\partial \underline{x}}{\partial z_2} + \underbrace{\begin{bmatrix} 0 & 1 & 0 & 0 \\ -1 & 0 & 0 & 0 \\ -1 & -1 & 0 & 1 \\ 0 & 0 & \gamma & 0 \end{bmatrix}}_{A_0} \underline{x} \quad \text{where } \underline{x} \equiv \begin{bmatrix} x_{z_1} \\ x_{z_2} \\ x \\ x_t \end{bmatrix}$$

Relativistic Fields (Mandl & Shaw 2010)

$$\text{Dirac Equation: } \frac{\partial \phi}{\partial t} = -c \left(\sum_{i=1}^3 \underbrace{A_i}_{\substack{\text{Pauli} \\ \text{Spin} \\ \text{Matrices}}} \frac{\partial \phi}{\partial x_i} \right) + \left(i \frac{mc^2}{\hbar} I_4 \right) \phi$$

Stability via Lyapunov-Barbalat

$$\text{Nonlinear Dynamics} \begin{cases} \dot{x} = f(x) \\ x(0) = x_0 \in \mathbb{R}^N \end{cases}$$

Find Energy - like Function : $V(x)$

$$V(x) > 0 \text{ when } x \neq 0$$

$$V(0) = 0$$

~~$$\dot{V} = \text{grad}V * f(x) < 0 \Rightarrow x(t) \rightarrow 0 \text{ as } t \rightarrow \infty \text{ for all } x_0$$~~

Often does
Not happen



$\dot{V} \leq 0 \Rightarrow$ All trajectories $x(t)$ are bounded

From Barbalat's lemma :

$\dot{V}(t) \leq 0$ and uniformly continuous $\Rightarrow \dot{V}(t) \rightarrow 0$ as $t \rightarrow \infty$



X Hilbert or Banach Space

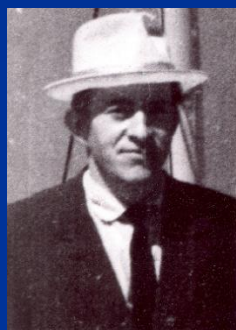
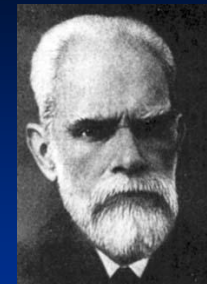

$$\text{Let } \begin{cases} V(t, x, \Delta G) \equiv V(t, x) + \frac{1}{2} \text{tr}(\Delta G \gamma^{-1} \Delta G^T) \\ \text{with } x(t) = U(t)x_0 \in X; t \geq 0 \end{cases}$$

Linear or Nonlinear Evolution

Theorem: If $\begin{cases} \alpha(\|(x, \Delta G)\|) \leq V(t, x, \Delta G) \leq \beta(\|(x, \Delta G)\|) \\ \dot{V}(t, x, \Delta G) \leq -W(x) \leq 0 \end{cases}$

and $\frac{dW(x(t))}{dt} = \left(\frac{\partial W}{\partial x} \right) \frac{\partial x(t)}{\partial t}$ is bounded, then $W(x(t)) \xrightarrow{t \rightarrow \infty} 0$ and ΔG bounded.

*Frechet
Derivative*

If $W(x)$ is coercive in the partial state x , or $W(x) \geq \gamma(\|x\|)$, then $x(t) \xrightarrow{t \rightarrow \infty} 0$.

Adaptive Model Tracking in the Presence of **Persistent** Disturbances

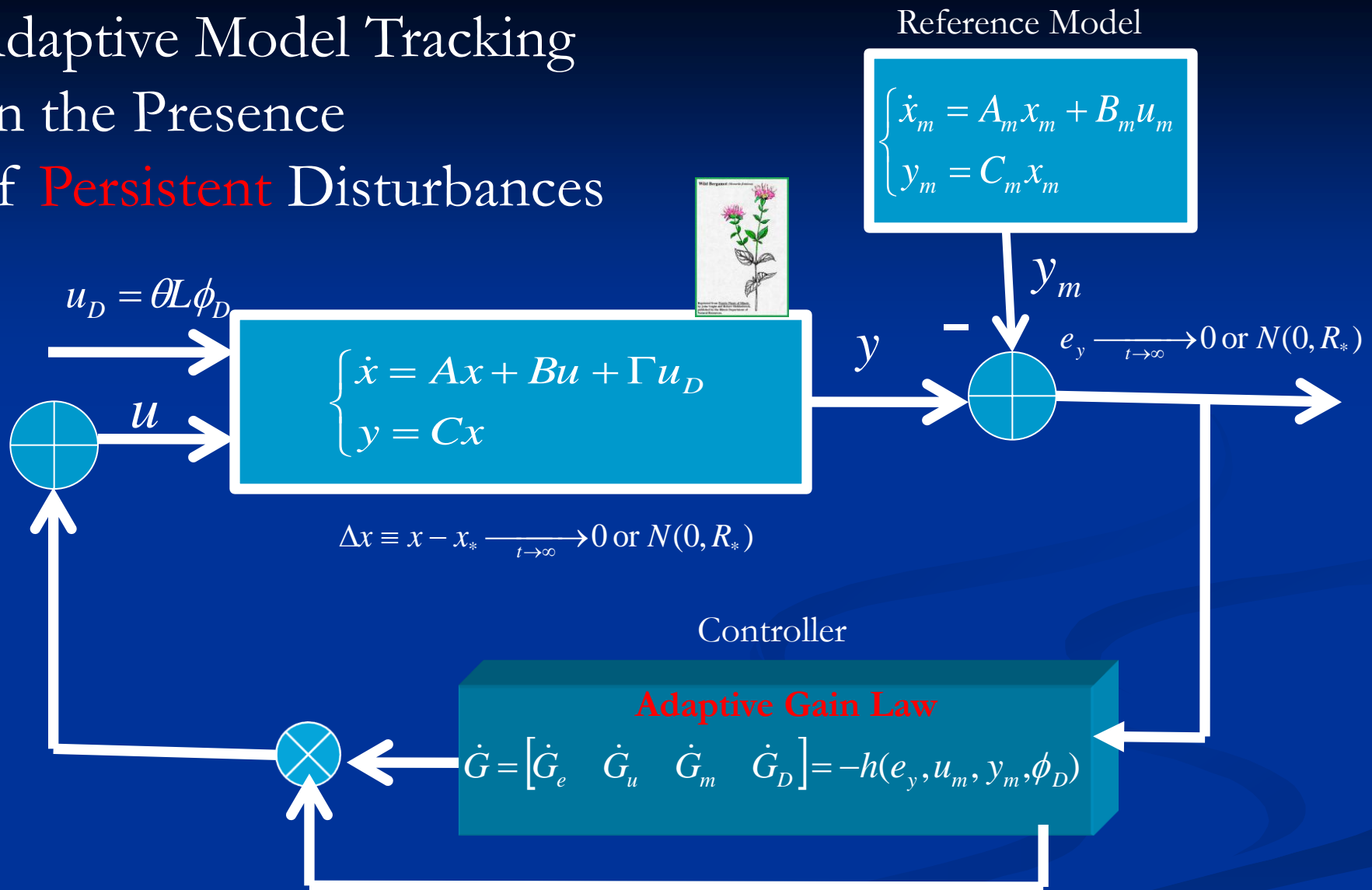

Adaptive Control Law

$$u = \underbrace{G_u u_m + G_m w_m}_{\text{Model Tracking}} + \underbrace{G_D \phi_D}_{\text{Disturbance Rejection}} + \underbrace{G_e e_y}_{\text{Stabilization}}$$

where

$$\begin{cases} \dot{G}_u = -e_y \cdot u_m^T \\ \dot{G}_m = -e_y \cdot x_m^T \\ \dot{G}_D = -e_y \cdot \phi_D^T \\ \dot{G}_e = -e_y \cdot e_y^T \end{cases}$$

Gain
Adaptation
Laws

Using Ideal Trajectories

Solar Power System Satellite

Long Ago
and Far Away

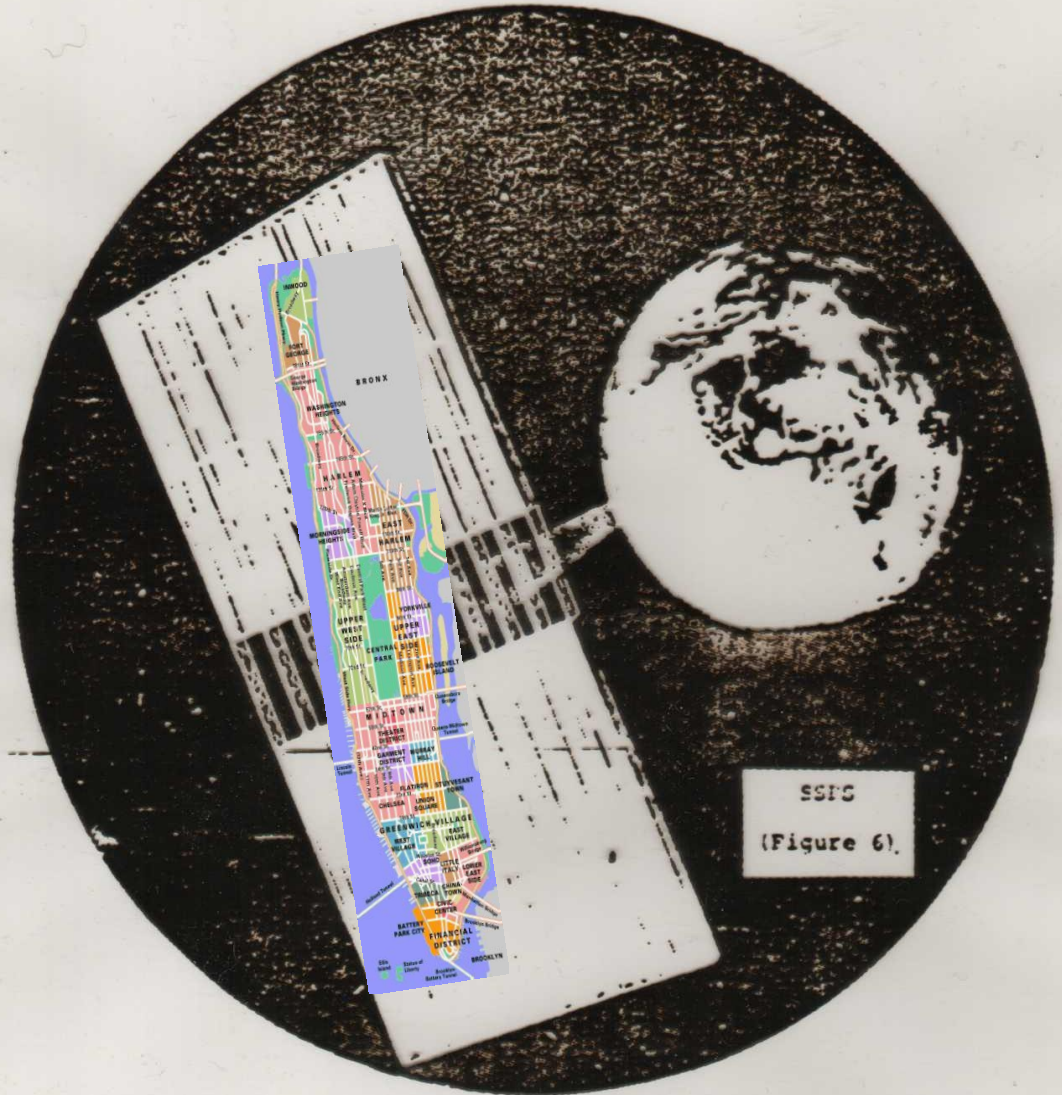

NASA-Johnson

Hubble, Bubble, Toil and Trouble

NASA MSEFC

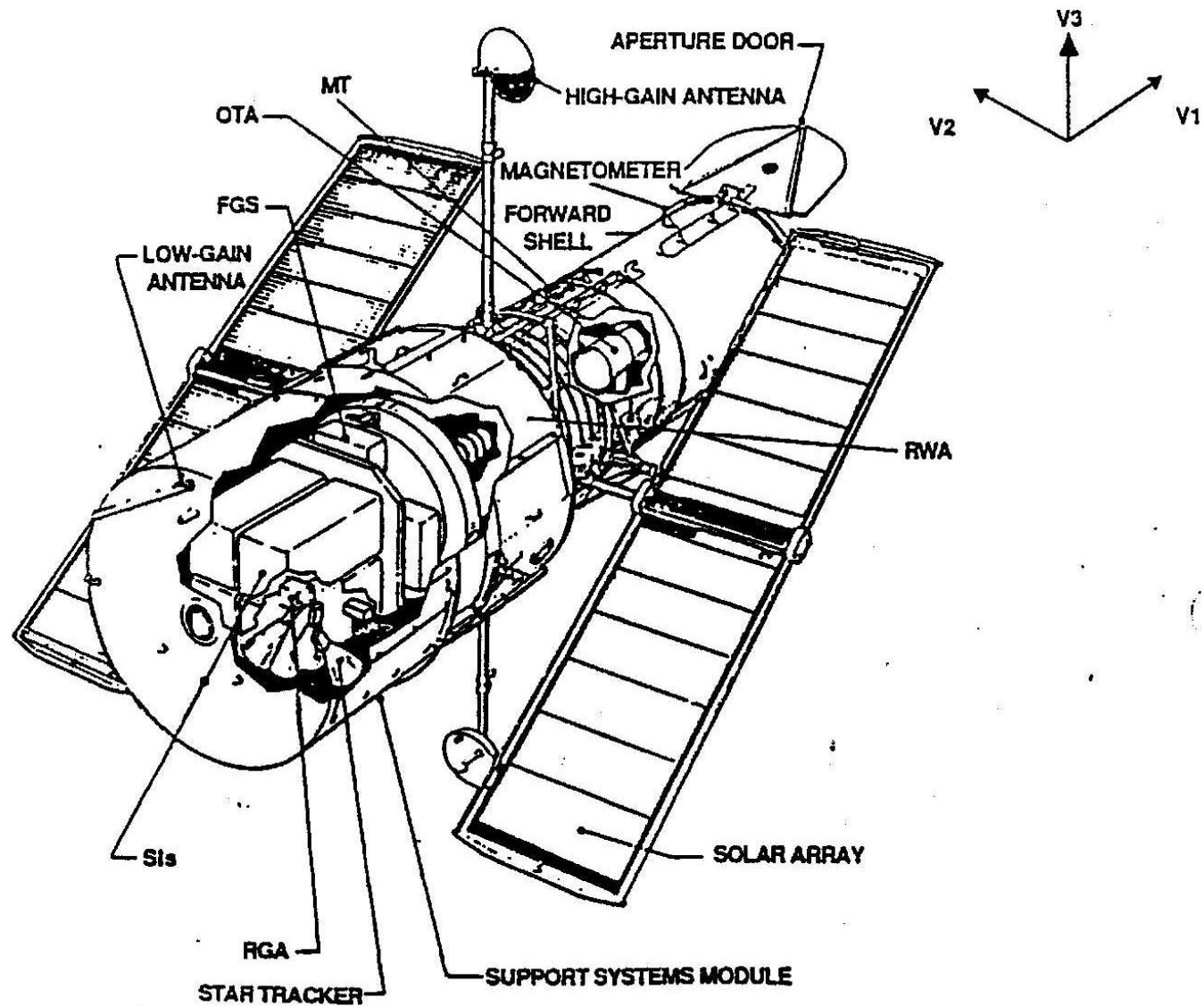
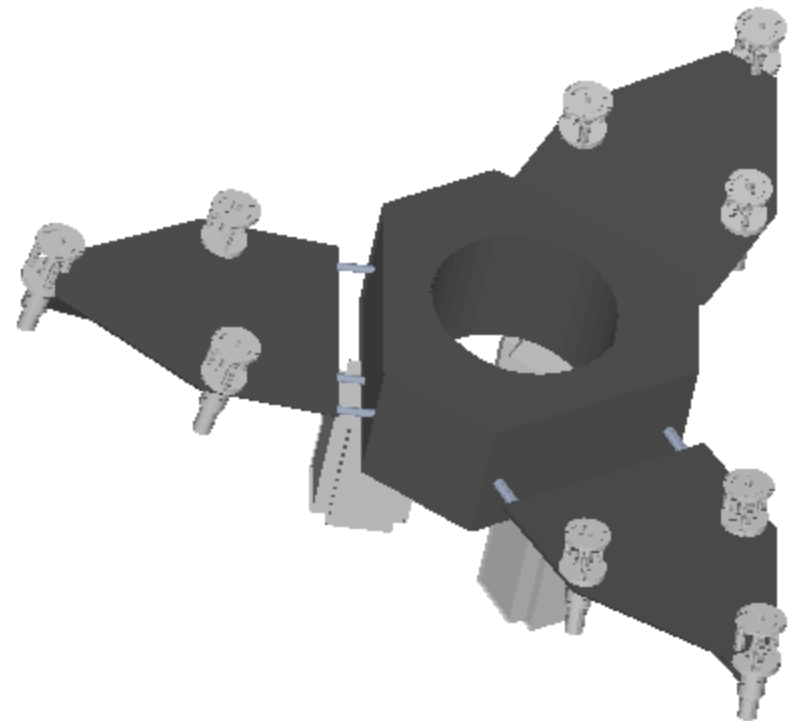

Figure 1-1. Hubble Space Telescope



Deployable
Optical Telescope
DOT

Primary Mirror
Supports



Deployable Optical Telescope Experiment

R. Fuentes, M. Balas, K. Schrader, and R.S. Erwin "Direct Adaptive Disturbance Rejection and Control for a Deployable Space Telescope, Theory and Application", Proceedings of ACC, Arlington, VA, June 2001.

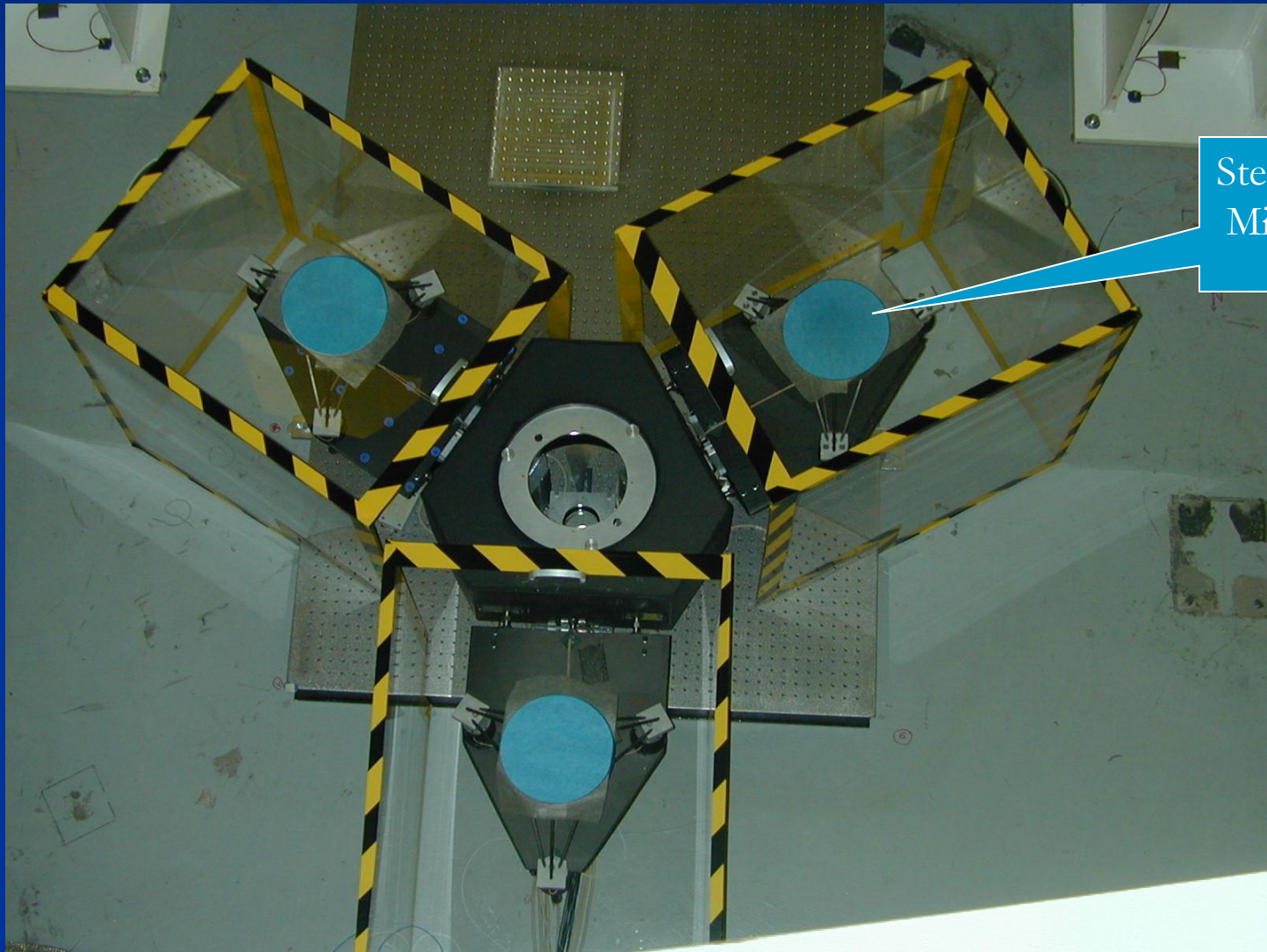

Steering
Mirrors

Evolving Systems

Evolving Systems=
Autonomously
Assembled
Active Structures

Or Self-Assembling
Structures,
which Aspire to a
Higher Purpose;
*Cannot be attained
by Components Alone*

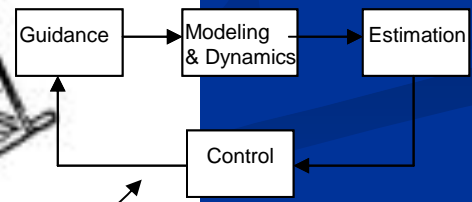
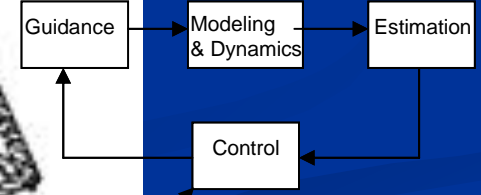
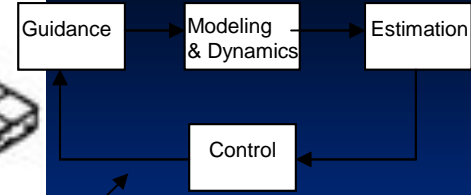
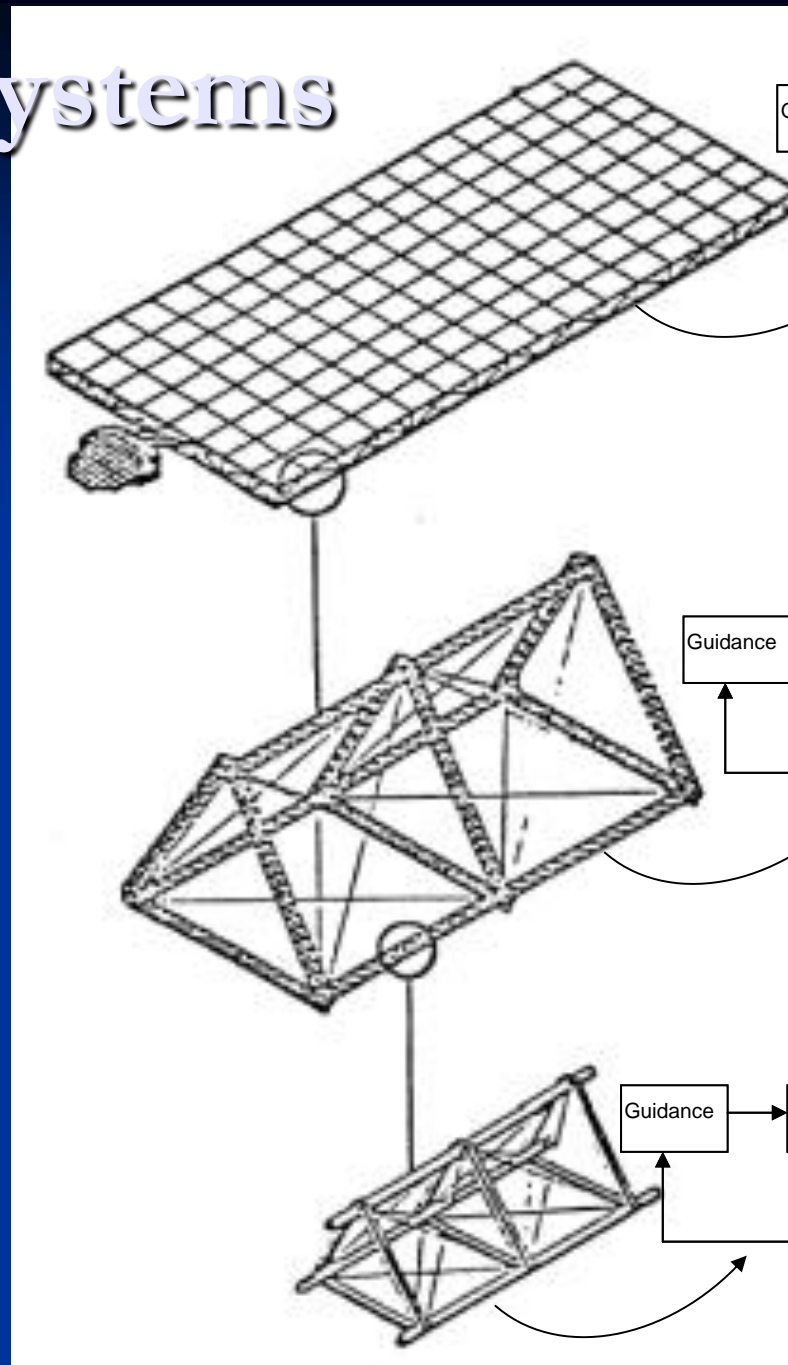

Genetics of Evolving Systems: Inheritance of Component Traits

- Controllability/Observability
- Stability
- Optimality
- Robustness
- Disturbance Rejection/Signal Tracking



Source: CNN.com



Stability is Necessary During the Entire Evolution Process

Irony: Synthetic Biology ???

Composability in Synthetic Biology

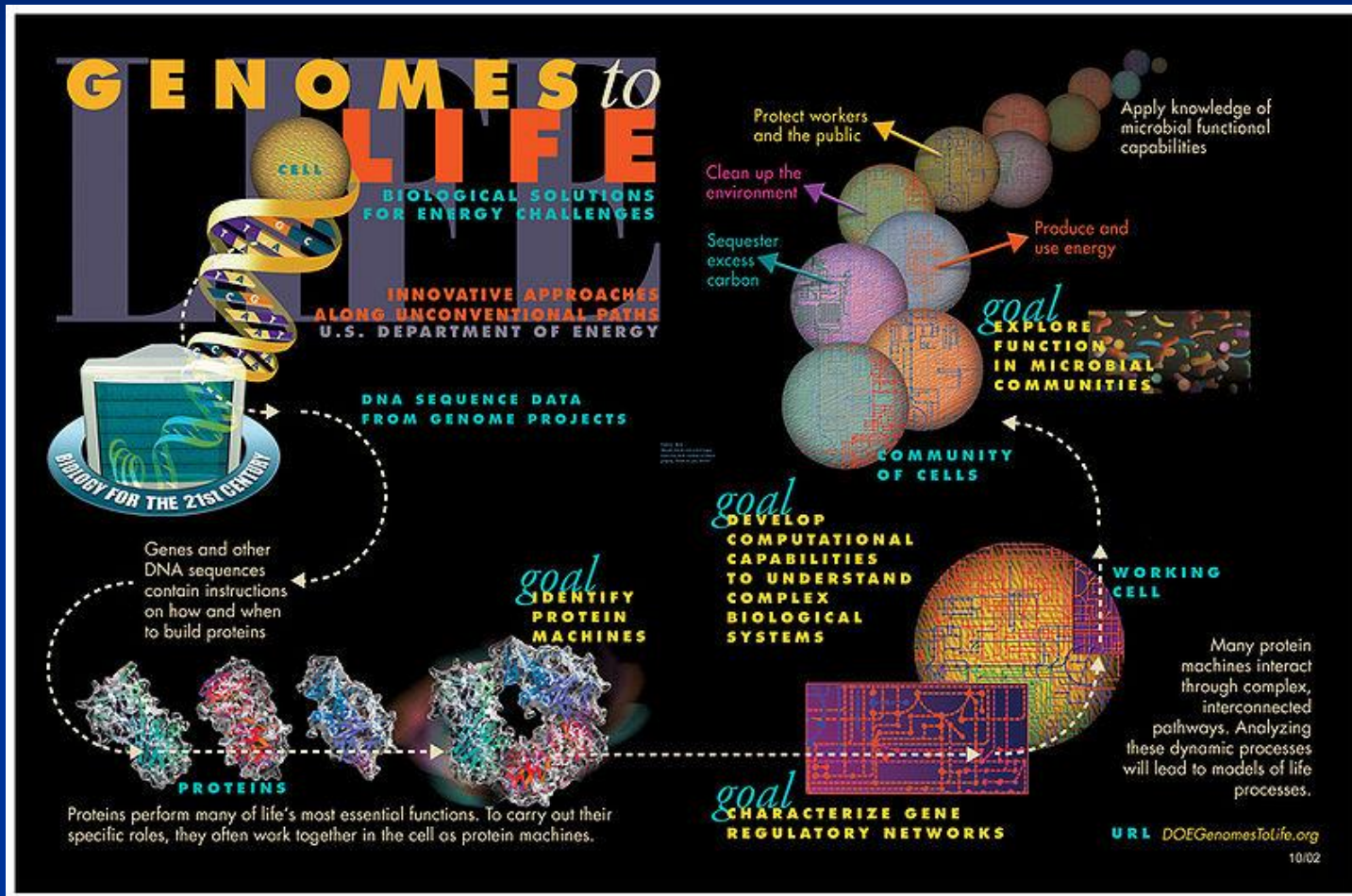

“It is difficult to define signal exchanges between biological units unambiguously”

F-16 Flexible Structure Model: Fluid-Structure Interaction



Flutter

USAF-Edwards AFB
Flight Test Center



One Possible Solution



Aerodynamically
Shaped Graduate
Student

Smart Grids: Virtual Interconnecting Forces

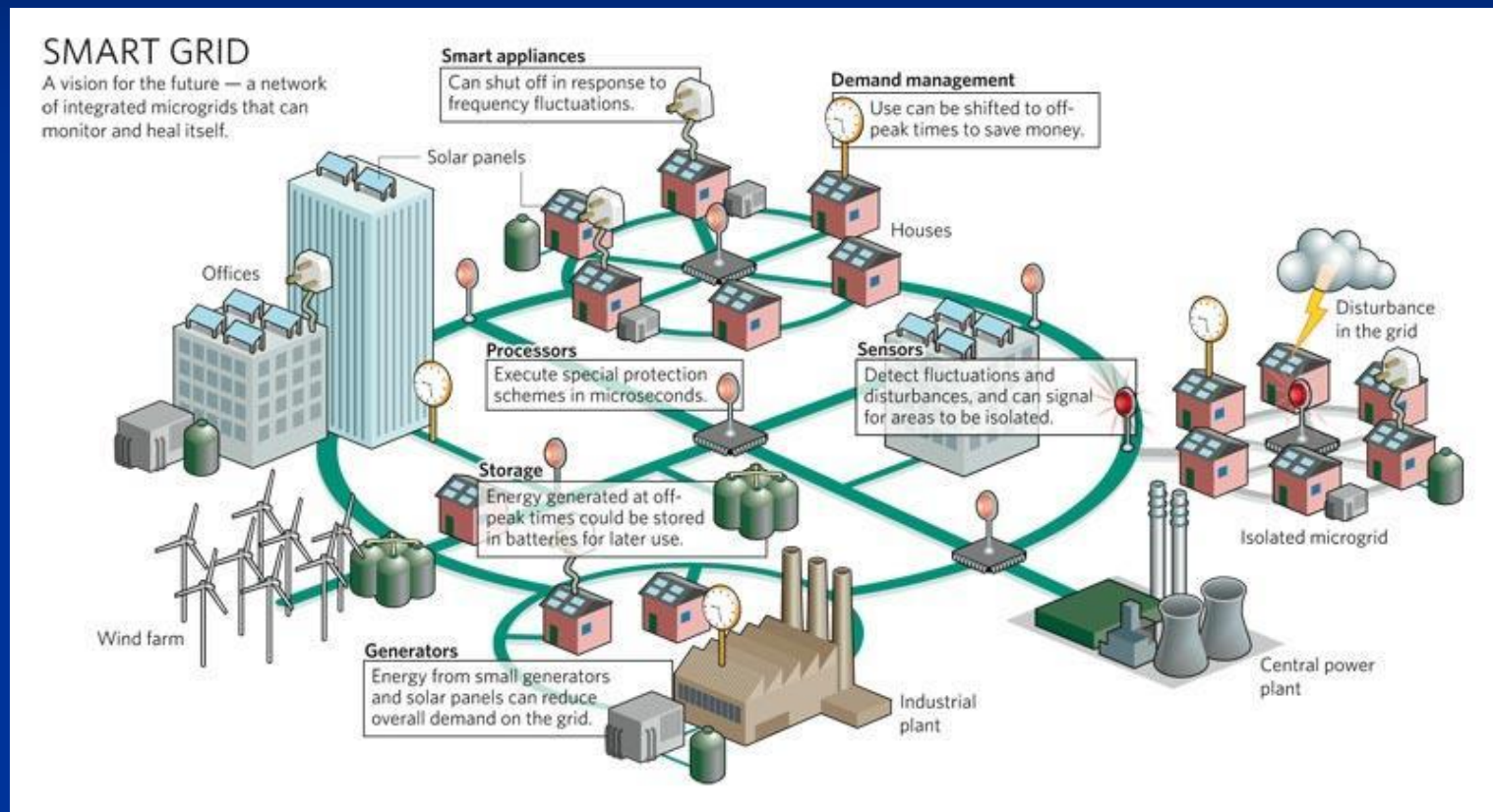

“It is surprising how quickly we replace a human operator with an algorithm and call it SMART”

Wind Energy

1979: 40 cents/kWh

2000: 4 - 6 cents/kWh

2006: 3 - 5 cents/kWh

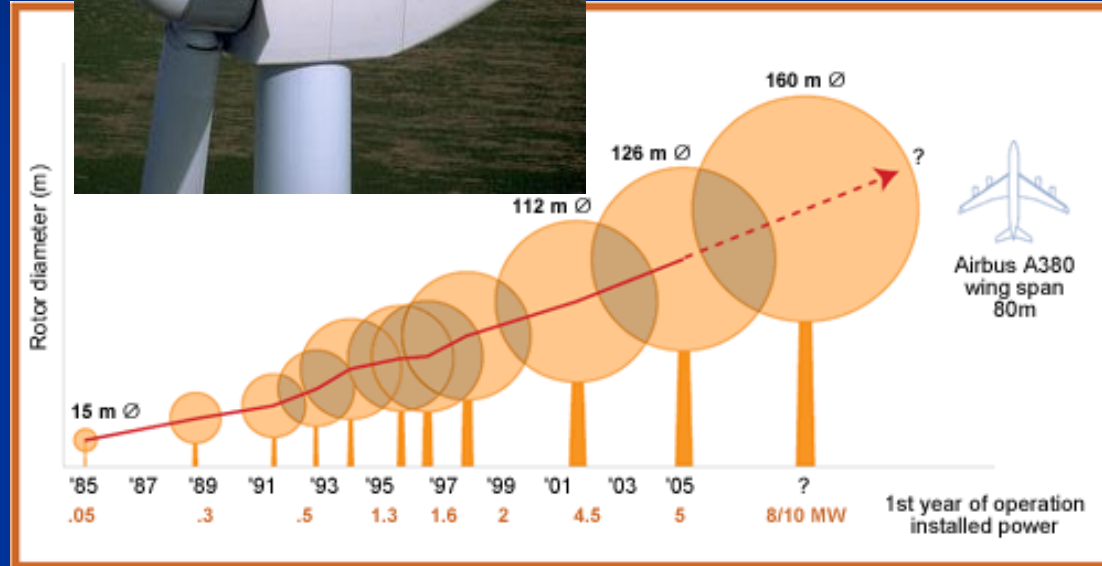

210 MW Lake Benton Wind Farm 4 cents/kWh

- R & D Advances
- Increased Turbine Size
- Manufacturing Improvements
- Large Wind Farms

Who Needs Control Anyway?



Flow Control of Wind Turbine Aerodynamics

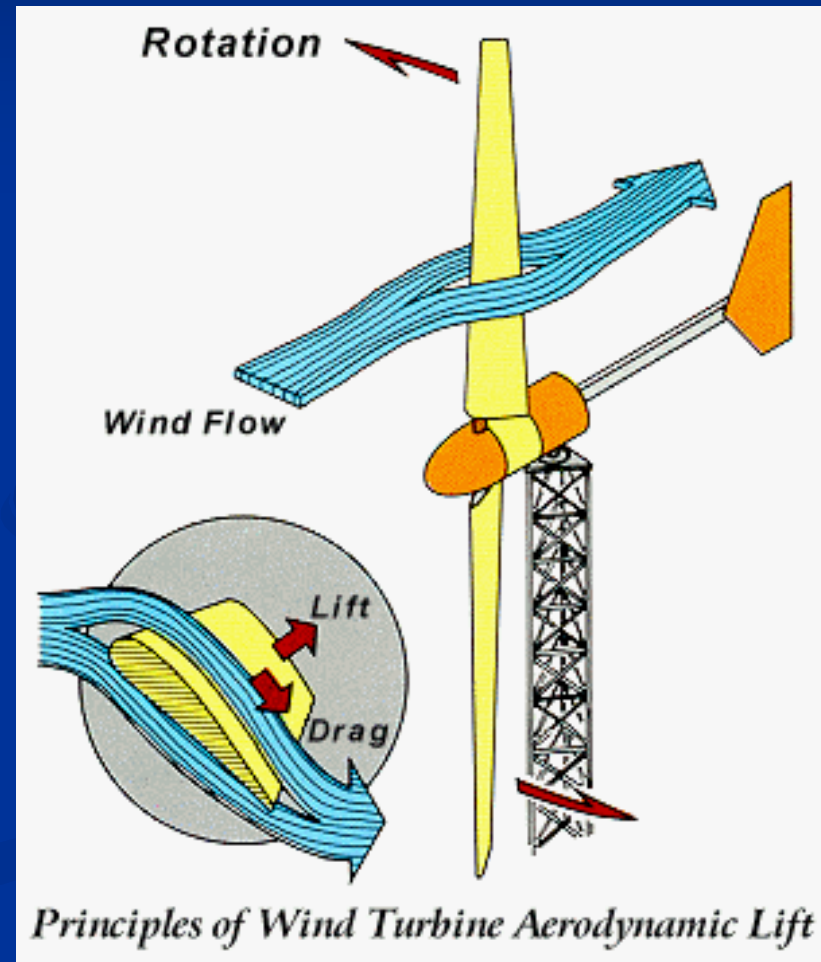
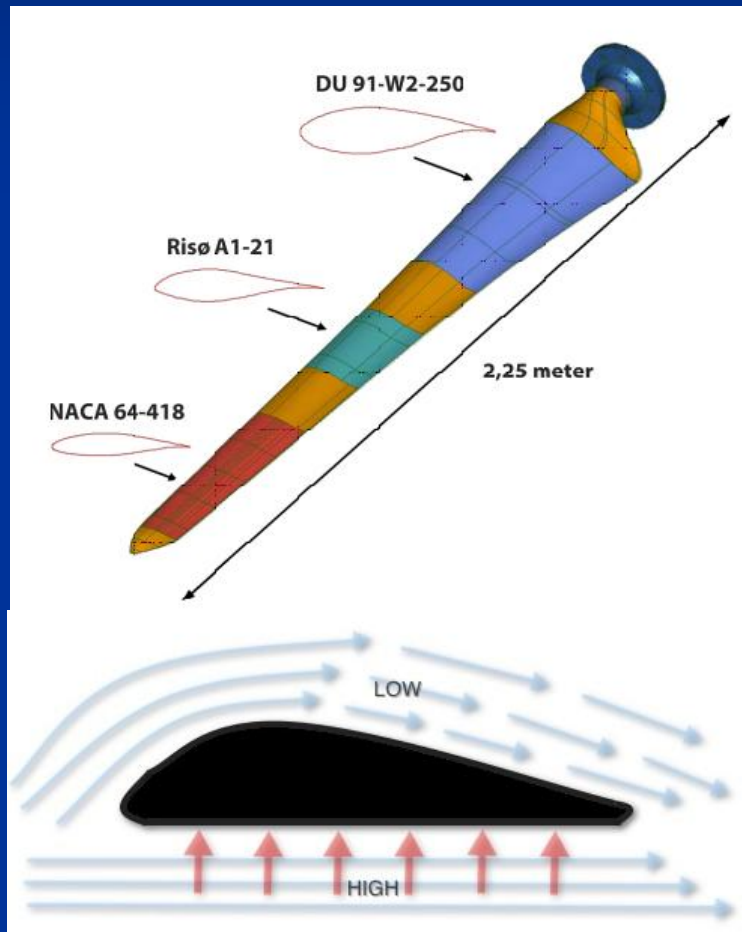

POWER SYSTEM PERTURBED WITH A WIND FARM

- When a wind farm is placed at a distance of α , the perturbed power system becomes :

$$\frac{\partial^2 \delta(u, t)}{\partial t^2} + \eta \frac{\partial \delta(u, t)}{\partial t} - v^2 \frac{\partial^2 \delta(u, t)}{\partial u^2} = W(u, t)$$

with $W(u, t) = P_g(t) \hat{\delta}(u - \alpha)$

- Power flow at a distance u is :

$$p(u, t) = -\frac{1}{\gamma} \frac{\partial \delta(u, t)}{\partial u}$$

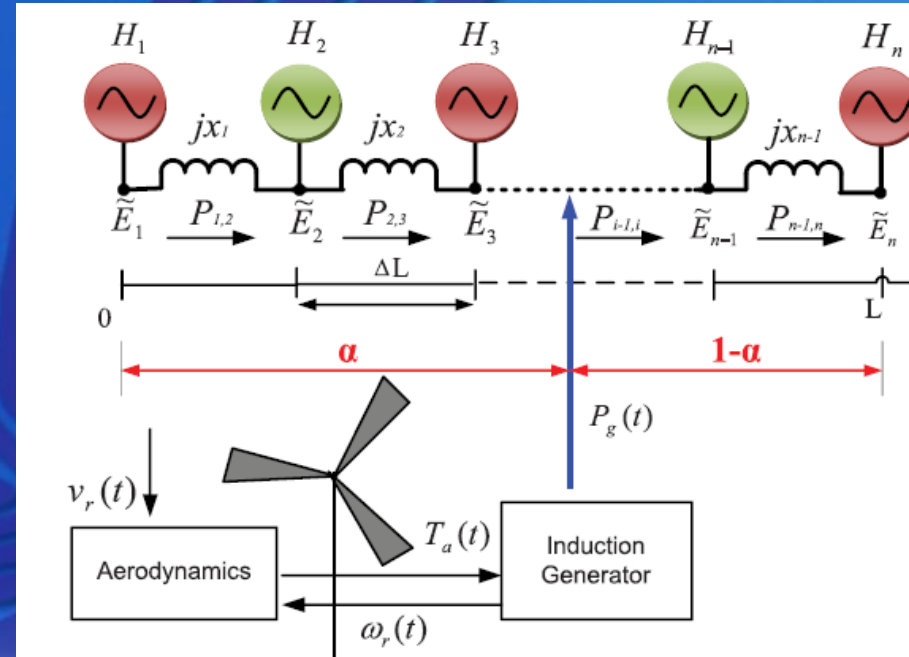

Adaptive Control in Quantum Information Systems

This might be the most
fundamental application
of direct adaptive control

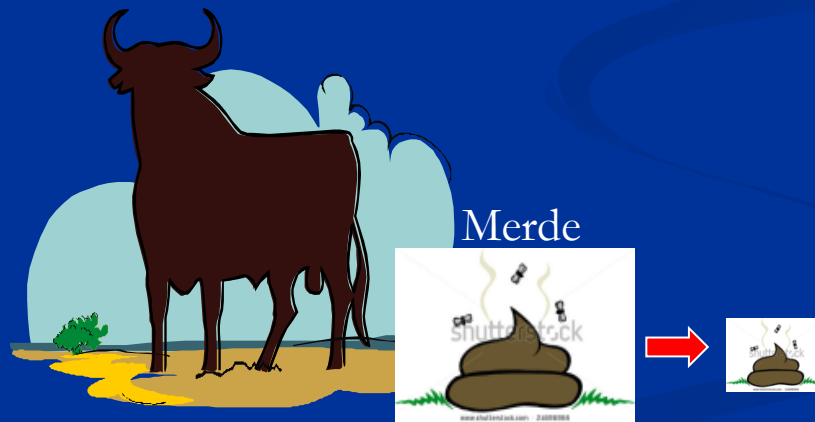

Quantum Computing

A Quantum computer will operate differently from a Classical one. It will be involved w physical systems on an atomic scale, eg atoms, photons, trapped ions, or nuclear magnetic moments



Unitary  Reversible

Could be improved with Adaptive Control
So Quantum Error Correction can work!!!

Quantum Information Systems

Erwin Schrödinger's Cat (1935)

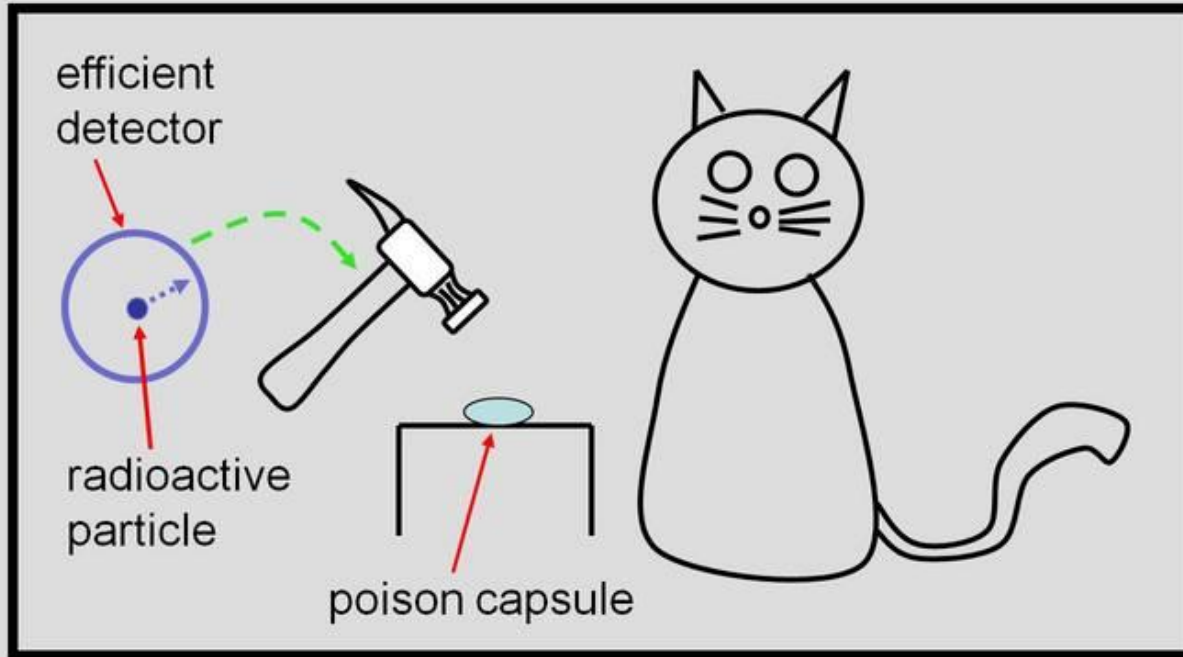

← sealed box

At "half-life of particle, cat is dead and alive!
"superposition"

$$\Psi = \left| \begin{array}{c} \text{circle with dot} \\ \text{circle with dot and arrow} \end{array} \right\rangle \left| \begin{array}{c} \text{cat face} \\ \text{cat face with X} \end{array} \right\rangle + \left| \begin{array}{c} \text{circle with dot and arrow} \\ \text{circle with dot} \end{array} \right\rangle \left| \begin{array}{c} \text{cat face with X} \\ \text{cat face} \end{array} \right\rangle$$

Quantum Basics (Dirac & Von Neumann)

Observable $A : X \xrightarrow{\substack{\text{bounded} \\ \text{self-adjoint}}} X$

$$\text{Compact Resolvent} \Rightarrow Ax = \sum_{k=1}^{\infty} \lambda_k \underbrace{(x, \varphi_k)}_{P_k x} \varphi_k$$

Pure States : φ_k eigenfunctions of A

Orthonormal
Eigen-Basis for X

State $\varphi \in X$ complex Hilbert Space :

$$(\varphi, \varphi) = 1 \text{ or } \|\varphi\| = 1 \Rightarrow \varphi = \sum_{k=1}^{\infty} c_k \varphi_k \quad \& \quad 1 = \|\varphi\|^2 = \sum_{k=1}^{\infty} |c_k|^2$$

\therefore "A state is a convex combination of pure states"

Schrodinger Wave Equation

$\varphi \in X$ complex Hilbert Space

$$i\hbar \frac{\partial \varphi}{\partial t} = \underbrace{H_0}_{\substack{\text{Self-Adjoint} \\ \text{Compact} \\ \text{Resolvent}}} \varphi + \underbrace{H_C(u)}_{\substack{\text{Control} \\ \text{Hamilton-} \\ \text{-ian}}} \varphi$$

Diffusion with
Imaginary Time :

$$t_{NEW} \equiv \frac{it_{OLD}}{\hbar}$$

\therefore Discrete Real Spectrum $\sigma(H_0) = \{\lambda_k\}_{k=1}^{\infty}$

$-\infty$



$\Rightarrow U_0(t) : X \rightarrow X$ Unitary Group (reversible)

and $U_0(t)\varphi = \sum_{k=1}^{\infty} e^{i\lambda_k t} \langle \varphi, \phi_k \rangle \phi_k$ with $\langle \phi_k, \phi_l \rangle = \delta_{kl}$

**Marginally
Stable**

Quantum Measurement

Entanglement

$$X = X_S \otimes X_M$$

$$\varphi = \sum_{k,l} \alpha_{kl} (\varphi_k^S \otimes \varphi_l^M) \neq h \otimes w$$

S

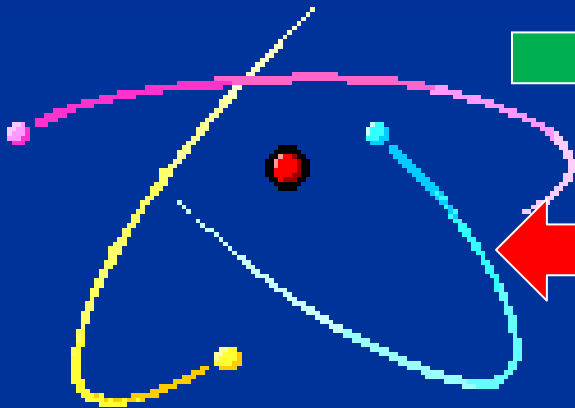

M



Back
Action

YOW!!



Ontology (what is) vs Epistemology (What is measured)

Uncertainty Principle

Observable $A : X \xrightarrow{\text{bounded self-adjoint}} X$ Hilbert

$\left\{ \begin{array}{l} \text{Mean } \langle A \rangle \equiv \text{Tr}(\rho A) \\ \text{Dispersion } \Delta A \equiv \sqrt{\text{Tr}(\rho(A - \langle A \rangle)^2)} \end{array} \right.$
 where ρ is a state or density operator ($\rho > 0$ & $\text{Tr}(\rho) = 1$)

Heisenberg Uncertainty Principle : Simultaneous Measurement of A & B

$$(\Delta A)^2 (\Delta B)^2 \geq \frac{\hbar}{2} |\text{Tr}(\rho[A, B])|; \text{commutator } [A, B] \equiv AB - BA \quad \text{Recall } (\Delta z)^2 (\Delta p)^2 \geq \left| \text{Tr}(\rho \underbrace{[z, p]}_{\frac{i\hbar}{2}}) \right| = \left(\frac{\hbar}{2}\right)^2$$

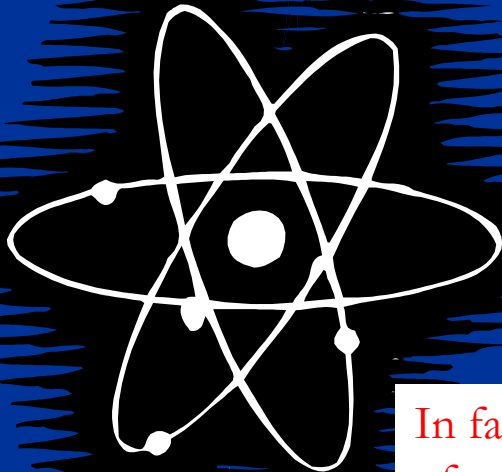

A Hilbert Space Property due to
Cauchy - Schwarz Inequality

$$0 \leq |(x, y)| \leq \|x\| \|y\|$$

In fact ALL of Quantum Mechanics is based on a Hilbert space of states and a (C^*) algebra of bounded linear self adjoint observables

Small Quantum Systems

- We can begin to experiment with just one electron, atom or small molecule
- Need:

Precise control

Isolation from the environment

Simple small systems : single particles or small groups of particles

..... David Wineland NIST

Control of Individual Quantum Systems: Quantum Feedback Loop

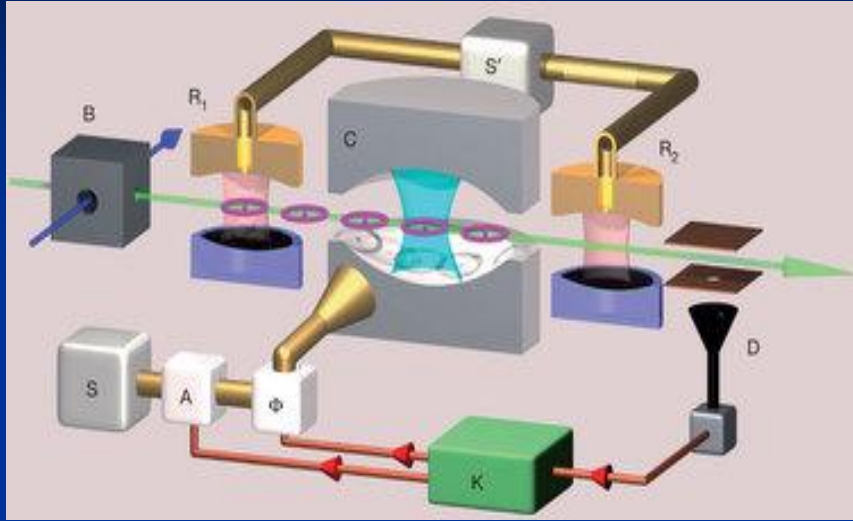

Physics Nobel Prize 2012
S. Haroche & D. Wineland

Purpose:

Use information from weak QND measurements to prepare photon number (Fock) states of a cavity field and protect them against decoherence.

Method:

Quantum feedback realized by atoms as QND probes and small coherent field injections into the cavity mode as an actuator.

Adaptive Quantum Model Tracking to Reduce Decoherence

Reference Model:
Closed System

Desired Hamiltonian
 H_*

Open Physical System



$$\begin{cases} i\hbar \frac{\partial \varphi}{\partial t} = \underbrace{H_0}_{\text{Self-Adjoint Compact Resolvent}} \varphi + \underbrace{H_C(u)}_{\text{Control}} \varphi + \underbrace{H_{\text{Linblad}}}_{\text{Disturbance}} \varphi \\ y = (c, \varphi) \end{cases}$$

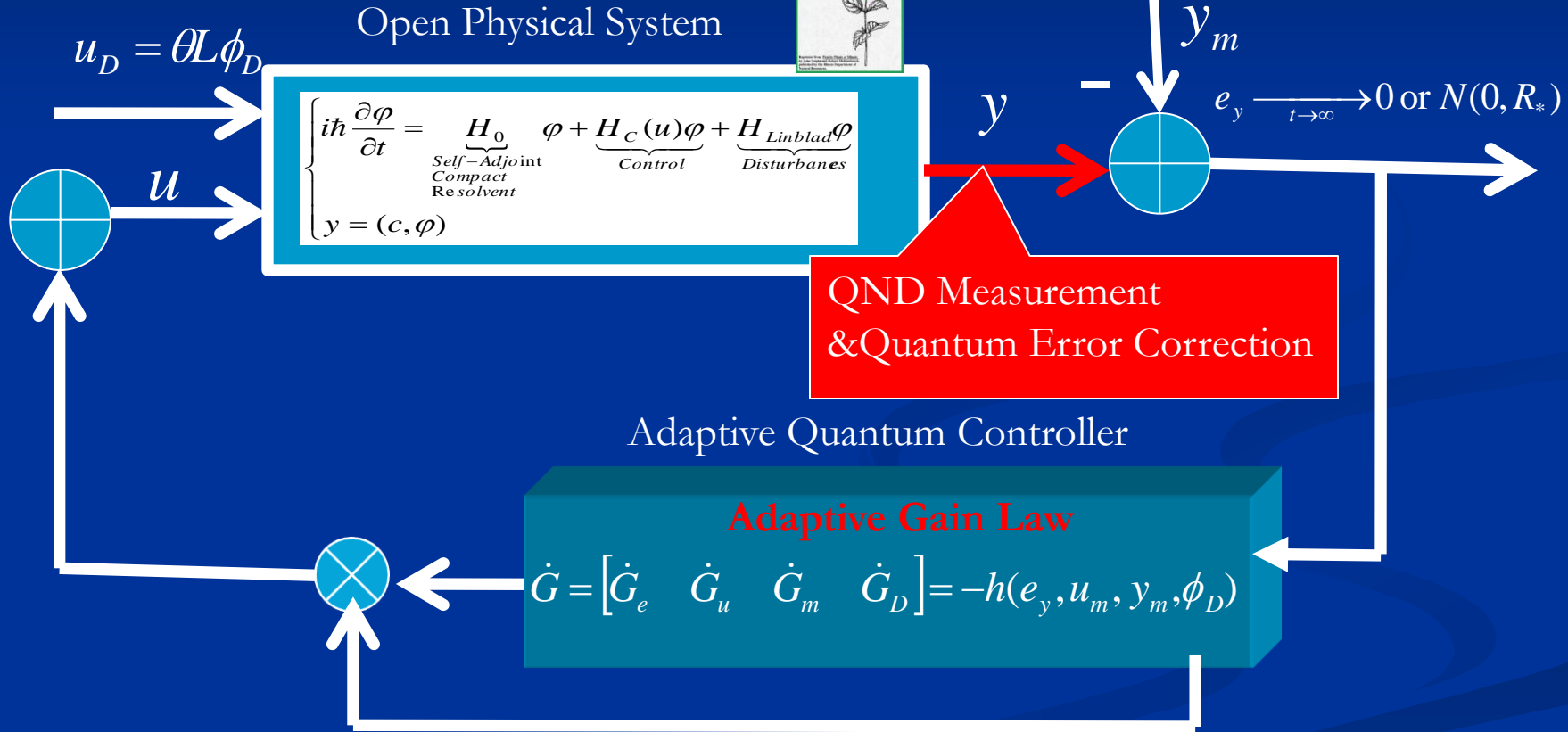

“~~Physics~~ is like sex: sure, it may give some practical results, but that's not why we do it.”

— Richard P. Feynman

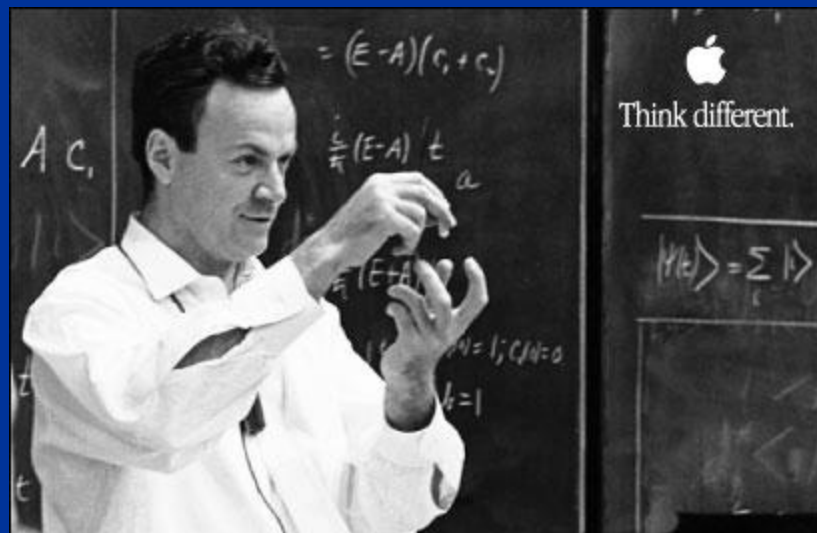

In a tile motif on the back of the Ross Dress For Less building on Lake Ave, Pasadena, CA